

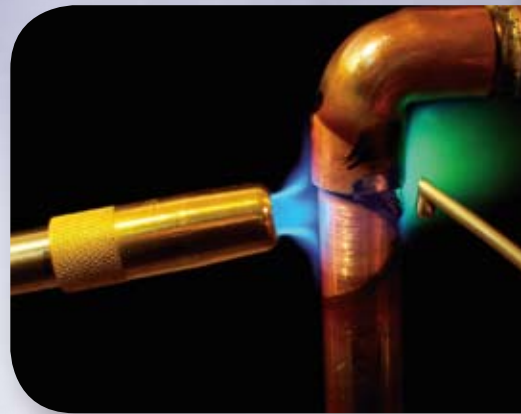

LAWSON Products



Industrial Supplies



Welding and Brazing



Chemicals

Something Special | June

Inside This Issue

- Page 4 – Metri-12 Fastening System Special Offer
- Page 8 – Stud Extraction Quick Tip
- Page 10 – NEW Cronatron™ Welding Systems and Solutions
- Page 11 – Blaze Out Flashback Arrestor Special Offer
- and Much More!

*Smarter Maintenance*SM

Cronatron[™]
A LAWSON BRAND

DRUMMOND[™]
A LAWSON BRAND

1-866-LAWSON4U
www.lawsonproducts.com

Multi-Maxx Workstation

Where Versatility Meets Functionality

It's more than just a tool cart; quickly and easily converts into a workstation. With two bulk storage areas, three sliding drawers and a top that doubles as a workbench, this will quickly become a favorite.

- Designed for industrial/tool professional – 740 lb. tool capacity; over 12,000 cubic inches
- Three tool drawers and two bulk storage areas
- Drawers feature ball slides for smooth, easy movement
- Locking detent pins prevent drawers from accidentally opening
- Pegboard-style side offers additional storage area
- 5" x 2" casters (two rigid; two swivel with locks)
- Drawer mats and keys included

Overall Dimensions

- 32-1/2"W x 20-1/2"D x 39-1/16"H (including casters)
- 49-1/2"W with optional folding plate installed

Top Bulk Storage Area

- 29-1/8"W x 20-1/4"D x 7-1/4"H

Sliding Drawers

- 24-5/16"W x 18-1/4"D x 3"H

Bottom Bulk Storage Area

- 25-5/8"W x 19"D x 8-1/4"H



TOOLS NOT INCLUDED



Folding Plate

- Increases top work area from 29-1/2" wide to 49-1/8" wide (a 66% increase!)



Adjustable Drawer Parts Organizer

- Place adjustable parts trays inside tool cart drawers to organize all your loose tools and parts

Aluminum Work Plate

- Turn the top of the tool cart into a heavy-duty, durable work area
- Can be used with optional folding plate



Pegboard Accessories

- These handy accessories attach onto pegboard side of Multi-Maxx WorkStation to keep tools within easy reach

DESCRIPTION	LAWSON NO.	PKG. QTY.
Multi-Maxx Workstation	FA5490	1
Adjustable Drawer Part Organizers, Vertical	FA5488	1
Adjustable Drawer Part Organizers, Horizontal	FA5489	1
Folding Plate	FA5491	1
Aluminum Work Plate	FA5492	1
Hook Pegboard Accessory	FA5493	1
Rectangle Pegboard Accessory	FA5494	1
Round Pegboard Accessory	FA5495	1
Screwdriver Tray Pegboard Accessory	FA5496	1



Engine Degreaser

Cuts through oils, baked-on grease, varnish and soil deposits. Easy to use – just spray on, allow to penetrate, and rinse with water. Low VOC formula is safer for the environment.



Contax™

High-Performance Electrical Cleaner

Quickly dissolves grease, oil and corrosion buildups – leaves no residue. Removes deposits that impair conductivity, restoring circuit performance. Non-conductive. Dielectric strength of 25.9kV/mil.

Description	Lawson No.	Pkg. Qty.
Contax™ 10 Oz. Net Wt. (283g) 16 Oz. Aerosol Can	P90390	1

Contax H.P.™

High-Pressure, Non-Conductive Electrical Cleaner

High-pressure, supercharged stream blasts away contaminants in hard-to-reach areas. Cuts through grease, oil and corrosion—evaporates quickly and leaves no residue. Non-conductive. Dielectric strength of 25.9kV/mil.

Description	Lawson No.	Pkg. Qty.
Contax H.P.™ 10 Oz. Net Wt. (283g) 16 Oz. Aerosol Can	P90393	1



ETP® General-Purpose Cutting Fluid

Reduces tool wear and results in cleaner cuts. Thickened formula clings to tool and cutting surface – ideal for applications involving high speeds and vibration. Perfect for tapping, cutting, drilling and reaming applications. Safe on all types of metals, including aluminum, titanium and stainless steel.

Description	Lawson No.	Pkg. Qty.
12 Oz. Squeeze Bottle	P93215	1



14-Piece Regency Electricians Spiral Point Tap and Drill Set

Set contains one each of Machine Screw Taps 6-32, 8-32, 10-24, 10-32 and 12-24, one each of USS Fractional Taps 1/4-20 and 5/16-18, and corresponding drill bits for all sizes.

Lawson Index No.	Lawson Set No.	Pkg. Qty.
A1130	26750	1



Regency Gold Pipe Tap Starter Set

Lawson's 5-piece Regency pipe tap starter set comes supplied with one 1/16-27, 1/8-27, 1/4-18, 3/8-18 and 1/2-14 pipe taps and a wood stand to store and organize all of your pipe taps. The wood stand can hold up to 10 pipe taps (from 11/16" up to 2" diameter taps).



Description	Lawson No.	Pkg. Qty.
5-Piece Pipe Tap Starter Set, Sizes 1/16" through 1/2"	63492	1

11-Piece Regency M42 Cobalt End Mill Set



Lawson's Regency End Mills are manufactured with M42 tool steel that has an 8% cobalt content for long tool life and high heat and abrasion resistance. Perfect for tough machining applications. Regency End Mills are TiN-coated (Titanium Nitride) – ideal for use on a wide range of applications and cutting conditions where tool life and higher feeds and speeds are required. Set includes one each of cutting diameters 1/8", 3/16", 1/4", 5/16", 3/8", 7/16", 1/2", 5/8", 3/4", 7/8" and 1", and comes in a durable metal storage case.



Description	Lawson No.	Pkg. Qty.
11-Pc. Set	91895	1

Citrisolv

Quickly degreases and cleans parts prior to assembly, inspection and machining. Removes adhesive residue and protective coatings such as cosmoline. Contains no ozone-depleting compounds and is safe on all types of metals, including aluminum and other alloys.

Description	Lawson No.	Pkg. Qty.
16 Oz. Can Size 15 Oz. Net Wt. Aerosol	54624	1



Abrasives

3M™ Roloc™ 4-1/2" Bristle Disc Kit

The 3M™ Roloc™ 4-1/2" Bristle Disc Kit includes one 4-1/2" diameter disc in each of the following grits: green (50 grit), yellow (80 grit) and white (120 grit). Bristle discs can be used in place of wire brushes, scrapers and chemical strippers. Bristle discs remove gasket material and paint. The open construction is non-loading.



Description	Lawson No.	Pkg. Qty.
4-1/2" Bristle Disc Kit	60741	1

*4-1/2" discs have 5/8-11 threaded arbors, designed for use on angle grinders.



Scotch-Brite® Surface Conditioning Stars

Scotch-Brite® Surface Conditioning Stars clean and polish the inside diameters of pipe, tubing and other interior spaces. For use on die grinders. Available in Fine and Coarse grits.



Size (Inches)	Grit	Color	RPM	I.D. Range (Inches)	Lawson No.	Pkg. Qty.
1-1/2	Fine	Blue	24,000	1 - 1-1/4	58110	5
2	Fine	Blue	24,000	1-1/4 - 1-3/4	58112	5
2	Coarse	Brown	24,000	1-1/4 - 1-3/4	58113	5
3	Fine	Blue	18,000	1-3/4 - 2-3/4	58114	2
3	Coarse	Brown	18,000	1-3/4 - 2-3/4	58115	2
4	Fine	Blue	18,000	2-3/4 - 3-3/4	58116	2
4	Coarse	Brown	18,000	2-3/4 - 3-3/4	58117	2



18680

3/8" Drive Teardrop Ratchets

Sealed narrow head design is as much as 23% narrower than competitive ratchets. 36-tooth gear ratchet has 10° arc.

Description	Length (Inches)	Number of Teeth	Lawson No.	Pkg. Qty.
Teardrop Ratchet w/ Chrome Finish	8	36	18680	1
Teardrop Ratchet, Long w/Chrome Finish	10-3/4	36	18681	1



LockJaw™ Self-Adjusting C-Clamp Pliers

Automatically locks on any size workpiece. Can apply over 2,500 lbs. of pressure.

Description	Lawson No.	Pkg. Qty.
7" C-Clamp	16473	1
11" C-Clamp	16474	1
7" C-Clamp w/Swivel Pad	16475	1
11" C-Clamp w/Swivel Pad	16476	1

5-Piece 3/8" Drive Extension Set

Includes 1-1/2", 3", 6", 11" and 18" extensions in a roll pouch.

Description	Lawson No.	Pkg. Qty.
3/8" Drive Extension Set	18665	1

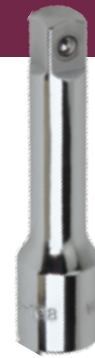

Heavy-Duty 4-in-1 Utility Clamp Sets

Heavy-duty versions of our 4-in-1 clamps with 1-9/16" x 3/4" rail size provide 4,800 pounds of clamping pressure. Each clamp comes with a V-pad and extender block.



Description	Dimension (Inches)	Lawson No.	Pkg. Qty.
16.5" Heavy-Duty Clamp, V-Pad, 2" Extender Block	23 x 11	CW5606	1
20.5" Heavy-Duty Clamp, V-Pad, 2" Extender Block	27 x 11	CW5607	1
24.5" Heavy-Duty Clamp, V-Pad, 2" Extender Block	31 x 11	CW5608	1
31.5" Heavy-Duty Clamp, V-Pad, 2" Extender Block	38 x 11	CW5609	1

PURCHASE this.... and RECEIVE this...

Metri-12 Fastening System

M6 to M12 dia., 12mm to 50mm capscrew lengths

- Metri-12 Property Class 12.9 Capscrews
- Metri-12 Property Class 12 Hex Thick Nuts
- Thru-Hardened Flat Washers • 658 pieces
- Designed for basic starter assortment, truck fleets, industrial equipment, small and medium farm equipment and forklifts



M6 Nut 98689	M6 Flat Washer 87508	M6 x 12 Capscrew 83443A	M6 x 16 Capscrew 83445A	M6 x 20 Capscrew 83447A	M6 x 25 Capscrew 83448A	M6 x 30 Capscrew 83449A	M6 x 50 Capscrew 83453A
M8 Nut 98690	M8 Flat Washer 87510	M8 x 12 Capscrew 83454A	M8 x 16 Capscrew 83455A	M8 x 20 Capscrew 83457A	M8 x 25 Capscrew 83459A	M8 x 30 Capscrew 83460A	M8 x 40 Capscrew 83462A
M10 Nut 98691	M10 Flat Washer 87511	M10 x 16 Capscrew 83470A	M10 x 20 Capscrew 83471A	M10 x 25 Capscrew 83472A	M10 x 30 Capscrew 83473A	M10 x 35 Capscrew 83474A	M10 x 40 Capscrew 83475A
M12 Nut 98692	M12 Flat Washer 87512	M12 x 25 Capscrew 83485A	M12 x 30 Capscrew 83486A	M12 x 35 Capscrew 83487A	M12 x 40 Capscrew 83488A	M12 x 45 Capscrew 83489A	M12 x 50 Capscrew 83490A

3/8" Drive Shallow 6 Point Metric Socket Set



Includes 12 sockets ranging from 8mm to 19mm on a clip rail.

at NO CHARGE!

To take advantage of this great offer order part number **MT605P**

Set includes MT605A and 18677

Offer valid June 1 – 30, 2008. Government entities or public, tax-supported institutions may not be eligible.

No substitutions on Metric Pre-planned Assortments



Carbide-Tipped Hole Cutters

The High Performance Tool for Drilling Thick Material up to 1" Thick

- Single Piece construction, no assembly required
- Specially-designed tungsten carbide teeth, excellent wear and heat resistance
- Safety collar stop, prevents over-penetration giving safer, faster operation

Applications

- Junction, switch boxes
- Metal studs
- Lighting fixtures
- Auto body repair
- Truck/trailer frames
- Ductile pipes



Cutter Dia. (Inches)	Depth of Cut (Inches)	Lawson No.	Pkg. Qty.
9/16	1	19692	1
5/8	1	19693	1
11/16	1	19694	1
3/4	1	19695	1
13/16	1	19696	1
7/8	1	19697	1
15/16	1	19698	1
1	1	19699	1
1-1/16	1	19700	1
1-1/8	1	19701	1
1-3/16	1	19702	1
1-1/4	1	19703	1
1-5/16	1	19704	1
1-3/8	1	19705	1
1-7/16	1	19706	1
1-1/2	1	19707	1
1-9/16	1	19708	1
1-5/8	1	19709	1
1-11/16	1	19710	1
1-3/4	1	19711	1
1-13/16	1	19712	1
1-7/8	1	19713	1
1-15/16	1	19714	1
2	1	19715	1

1-13/16" through 2" dia. tools have a 1/2" shank body with a 3/8" flatted shank.



Hole Cutter Sets

Description	Lawson No.	Pkg. Qty.
4-Piece Carbide-Tipped Hole Cutter Set	19716	1
4-Piece Carbide-Tipped Hole Cutter Set	19717	1
5-Piece Carbide-Tipped Hole Cutter Set	19718	1

19716 contains one of each cutter dia.: 5/8", 3/4", 7/8" and 1".
 19717 contains one of each cutter dia.: 11/16", 13/16", 15/16" and 1-1/16".
 19718 contains one of each cutter dia.: 7/8", 1-1/8", 1-3/8", 1-3/4" and 2".



14-Piece Regency Holesaw Wall Rack Starter Kit

Lawson's new Regency Holesaw Wall Rack Starter Kit comes supplied with 12 of our most popular Regency holesaw diameters, two arbors and one A1R29 Holesaw Wall Rack. Kit contains one each of the following holesaw diameters: 3/4", 7/8", 1", 1-1/8", 1-1/4", 1-3/8", 1-1/2", 1-3/4", 2", 2-1/4", 2-1/2", 3". You will also receive one arbor that fits 9/16" through 1-1/16" holesaws and one arbor that fits 1-1/4" through 6" holesaws. The A1R29 wall rack stores holesaws from 9/16" through 6" diameter.

Description	Lawson No.	Pkg. Qty.
Holesaw Wall Rack Starter Kit	18297	1

37-Piece Professional Bore Brush Set

Perfect for cleaning bushings, cylinder holes, clogged ports, battery terminal clamps and much more. Set contains 36 brushes (12 each of nylon, steel and brass) in sizes ranging from 8mm – 19mm (5/16" – 3/4") and a 1/4" hex locking driver.

Description	Lawson No.	Pkg. Qty.
37-Piece Bore Brush Set	18448	1



Dry Diamond Blades for Masonry Materials

- Blades deliver a smoother, faster cut with less dust and a constant depth of cut
- Dry blades are used where water is not permitted or not convenient
- Cuts through reinforcement typically found in masonry materials



Continuous Rim (Serrated) Blade

Faster cutting with little chipping, better cooling and quick removal of fines. Ideal for use on roof tile, masonry (brick/block) and concrete (slab/pipe).



Segmented Rim Blade

Provides maximum life and cutting strength. Ideal for use on concrete (slabs/walls/pipe), asphalt and masonry (brick/block).

Dia. Inches (mm)	Blade Type	Arbor Size	Maximum RPM	Lawson No.	Pkg. Qty.
4 (100)	Continuous Rim	5/8" or 20mm	15,000	64705	1
4-1/2 (125)	Continuous Rim	5/8" or 7/8"	15,000	64706	1
7 (175)	Continuous Rim	5/8" or DM*	7,500	64707	1
4 (100)	Segmented	5/8" or 20mm	15,000	64708	1
4-1/2 (125)	Segmented	5/8" or 7/8"	15,000	64709	1
7 (175)	Segmented	5/8" or DM*	7,500	64710	1
12 (300)	Segmented	1"	5,095	64711	1
14 (350)	Segmented	1"	3,820	64712**	1

*DM: Diamond Knock Out

**14" dia. blades have a pin hole.

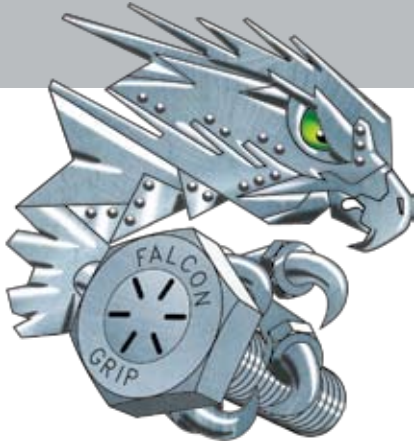

Let Lawson help you save time and money by having the right part, at the right place, at the right time. Lawson offers hundreds of pre-planned or custom assortments to help keep your business running.

FalconGrip CT Assortments

1/4" through 1/2" dia. capscrews, nuts and washers



CT197A Grade 8 UNC Fastening System

- 150,000 PSI minimum tensile strength
- 3,200 pieces

NEW!

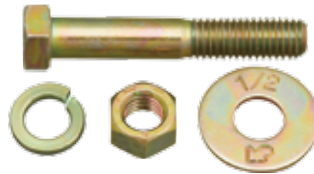

CT195A Grade 5 UNC Fastening System

- 120,000 PSI minimum tensile strength
- 3,650 pieces

NEW!

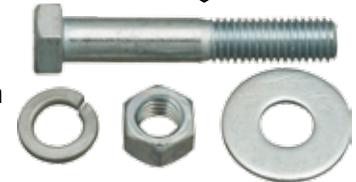

Lawson No.	Description	Lawson No.	Description
FA68400	1/4-20 Hex Nut	FA68046	7/16-14 x 1 FalconGrip Capscrew
FA68401	5/16-18 Hex Nut	FA68060	1/2-13 x 1 FalconGrip Capscrew
FA68402	3/8-16 Hex Nut	FA68001	1/4-20 x 3/4 FalconGrip Capscrew
FA68403	7/16-14 Hex Nut	FA68017	5/16-18 x 1 FalconGrip Capscrew
FA68404	1/2-13 Hex Nut	FA68032	3/8-16 x 1 FalconGrip Capscrew
FA88445	1/4 Flat Washer	FA68047	7/16-14 x 1-1/4 FalconGrip Capscrew
FA88446	5/16 Flat Washer	FA68062	1/2-13 x 1-1/2 FalconGrip Capscrew
FA88447	3/8 Flat Washer	FA68002	1/4-20 x 1 FalconGrip Capscrew
FA88448	7/16 Flat Washer	FA68018	5/16-18 x 1-1/4 FalconGrip Capscrew
FA88449	1/2 Flat Washer	FA68034	3/8-16 x 1-1/2 FalconGrip Capscrew
FA528A	1/4 Lockwasher	FA68048	7/16-14 x 1-1/2 FalconGrip Capscrew
FA529A	5/16 Lockwasher	FA68064	1/2-13 x 2 FalconGrip Capscrew
FA530A	3/8 Lockwasher	FA68003	1/4-20 x 1-1/4 FalconGrip Capscrew
FA531A	7/16 Lockwasher	FA68019	5/16-18 x 1-1/2 FalconGrip Capscrew
FA532A	1/2 Lockwasher	FA68036	3/8-16 x 2 FalconGrip Capscrew
FA68000	1/4-20 x 1/2 FalconGrip Capscrew	FA68050	7/16-14 x 2 FalconGrip Capscrew
FA68016	5/16-18 x 3/4 FalconGrip Capscrew	FA68066	1/2-13 x 2-1/2 FalconGrip Capscrew
FA68031	3/8-16 x 3/4 FalconGrip Capscrew		

Lawson No.	Description	Lawson No.	Description
FA95677	1/4-20 Hex Nut	FA65045	7/16-14 x 1 FalconGrip Capscrew
FA95678	5/16-18 Hex Nut	FA65060	1/2-13 x 1 FalconGrip Capscrew
FA95679	3/8-16 Hex Nut	FA65001	1/4-20 x 3/4 FalconGrip Capscrew
FA95680	7/16-14 Hex Nut	FA65017	5/16-18 x 1 FalconGrip Capscrew
FA95681	1/2-13 Hex Nut	FA65032	3/8-16 x 1 FalconGrip Capscrew
FA501	1/4 Flat Washer	FA65047	7/16-14 x 1-1/4 FalconGrip Capscrew
FA502	5/16 Flat Washer	FA65062	1/2-13 x 1-1/2 FalconGrip Capscrew
FA503	3/8 Flat Washer	FA65002	1/4-20 x 1 FalconGrip Capscrew
FA504	7/16 Flat Washer	FA65018	5/16-18 x 1-1/4 FalconGrip Capscrew
FA505	1/2 Flat Washer	FA65034	3/8-16 x 1-1/2 FalconGrip Capscrew
FA528	1/4 Lockwasher	FA65048	7/16-14 x 1-1/2 FalconGrip Capscrew
FA529	5/16 Lockwasher	FA65064	1/2-13 x 2 FalconGrip Capscrew
FA530	3/8 Lockwasher	FA65003	1/4-20 x 1-1/4 FalconGrip Capscrew
FA531	7/16 Lockwasher	FA65019	5/16-18 x 1-1/2 FalconGrip Capscrew
FA532	1/2 Lockwasher	FA65036	3/8-16 x 2 FalconGrip Capscrew
FA65000	1/4-20 x 1/2 FalconGrip Capscrew	FA65050	7/16-14 x 2 FalconGrip Capscrew
FA65016	5/16-18 x 3/4 FalconGrip Capscrew	FA65066	1/2-13 x 2-1/2 FalconGrip Capscrew
FA65031	3/8-16 x 3/4 FalconGrip Capscrew		

LP672 Steel Hose Adapters, Hex Head Pipe Plugs and JIC Caps and Plugs

Time to refill the fastest moving adapters in the 80% Solution.

LAWSON NO.	DESCRIPTION	LAWSON NO.	DESCRIPTION
86191	1/8 Hex Head Pipe Plug	86152	5/8 Cap Nut, JIC 37°
86192	1/4 Hex Head Pipe Plug	86153	3/4 Cap Nut, JIC 37°
86193	3/8 Hex Head Pipe Plug	86154	1 Cap Nut, JIC 37°
86194	1/2 Hex Head Pipe Plug	86197	1/4 Plug, JIC 37°
86195	3/4 Hex Head Pipe Plug	86198	5/16 Plug, JIC 37°
86196	1 Hex Head Pipe Plug	86199	3/8 Plug, JIC 37°
86148	1/4 Cap Nut, JIC 37°	86200	1/2 Plug, JIC 37°
86149	5/16 Cap Nut, JIC 37°	86201	5/8 Plug, JIC 37°
86150	3/8 Cap Nut, JIC 37°	86202	3/4 Plug, JIC 37°
86151	1/2 Cap Nut, JIC 37°	86203	1 Plug, JIC 37°



LP673 Steel Hose Adapters, O-Ring Boss and FFOR Plugs

Time to refill the fastest moving adapters in the 80% Solution.

LAWSON NO.	DESCRIPTION	LAWSON NO.	DESCRIPTION
86220	1/4 O-Ring Boss Plug	52543	9/16-18 (-4) Flat Face O-Ring Plug
86221	3/8 O-Ring Boss Plug	52544	11/16-16 (-6) Flat Face O-Ring Plug
86222	1/2 O-Ring Boss Plug	52545	13/16-16 (-8) Flat Face O-Ring Plug
86223	5/8 O-Ring Boss Plug	52546	1-14 (-10) Flat Face O-Ring Plug
86224	3/4 O-Ring Boss Plug	52547	1-3/16-12 (-12) Flat Face O-Ring Plug
86374	1 O-Ring Boss Plug	52548	1-7/16-12 (-16) Flat Face O-Ring Plug



LP432 Super 77 Hose Clamps, 300 Stainless Steel

Make sure that you never run out of clamps.

Lawson No.	Description
86327	SAE Size 4, 7/32 - 5/8 Clamping Range
85494	SAE Size 6, 7/16 - 7/8 Clamping Range
85495	SAE Size 8, 7/16 - 1 Clamping Range
85496	SAE Size 10, 1/2 - 1-1/8 Clamping Range
85497	SAE Size 12, 5/8 - 1-1/4 Clamping Range
85498	SAE Size 16, 3/4 - 1-1/2 Clamping Range
85499	SAE Size 20, 7/8 - 1-3/4 Clamping Range





LP Assortments

Grade 5 and Grade 8 – UNC

All LP Assortments include A12 drawer.

LP790 1/4–20 Grade 5

1,101 Pieces

NEW!

Description	Part No.	Qty.
1/4–20 Hex Nut	FA95677	100
1/4" USS Flat Washer	FA501	250
1/4" Lockwasher	FA528	250
1/4–20 x 1/2" Capscrew	FA65000	100
1/4–20 x 3/4" Capscrew	FA65001	100
1/4–20 x 1" Capscrew	FA65002	100
1/4–20 x 1-1/4" Capscrew	FA65003	100
1/4–20 x 1-1/2" Capscrew	FA65004	100

LP791 5/16–18 Grade 5

950 Pieces

NEW!

Description	Part No.	Qty.
5/16–18" Hex Nut	FA95678	100
5/16" USS Flat Washer	FA502	250
5/16" Lockwasher	FA529	250
5/16–18 x 3/4" Capscrew	FA65016	100
5/16–18 x 1" Capscrew	FA65017	100
5/16–18 x 1-1/4" Capscrew	FA65018	50
5/16–18 x 1-1/2" Capscrew	FA65019	50
5/16–18 x 2" Capscrew	FA65021	50



LP792 3/8–16 Grade 5

650 Pieces

NEW!

Description	Part No.	Qty.
3/8–16" Hex Nut	FA95679	100
3/8" USS Flat Washer	FA503	250
3/8" Lockwasher	FA530	100
3/8–16 x 3/4" Capscrew	FA65031	50
3/8–16 x 1" Capscrew	FA65032	50
3/8–16 x 1-1/2" Capscrew	FA65034	50
3/8–16 x 2" Capscrew	FA65036	25
3/8–16 x 2-1/2" Capscrew	FA65038	25

LP793 7/16–14 Grade 5

425 Pieces

NEW!

Description	Part No.	Qty.
7/16–14" Hex Nut	FA95680	50
7/16" USS Flat Washer	FA504	100
7/16" Lockwasher	FA531	100
7/16–14 x 1" Capscrew	FA65046	50
7/16–14 x 1-1/4" Capscrew	FA65047	50
7/16–14 x 1-1/2" Capscrew	FA65048	25
7/16–14 x 2" Capscrew	FA65050	25
7/16–14 x 2-1/2" Capscrew	FA65052	25

LP794 1/2–13 Grade 5

425 Pieces

NEW!

Description	Part No.	Qty.
1/2–13" Hex Nut	FA95681	50
1/2" USS Flat Washer	FA505	100
1/2" Lockwasher	FA532	100
1/2–13 x 1" Capscrew	FA65060	50
1/2–13 x 1-1/2" Capscrew	FA65062	50
1/2–13 x 2" Capscrew	FA65064	25
1/2–13 x 2-1/2" Capscrew	FA65066	25
1/2–13 x 3" Capscrew	FA65068	25

LP795 1/4–20 Grade 8

950 Pieces

NEW!

Description	Part No.	Qty.
1/4–20" Hex Nut	FA68400	100
1/4" USS Flat Washer	FA88445	100
1/4" Alloy Lockwasher	FA526A	250
1/4–20 x 1/2" Capscrew	FA68000	100
1/4–20 x 3/4" Capscrew	FA68001	100
1/4–20 x 1" Capscrew	FA68002	100
1/4–20 x 1-1/4" Capscrew	FA68003	100
1/4–20 x 1-1/2" Capscrew	FA68004	100

LP796 5/16–18 Grade 8

750 Pieces

NEW!

Description	Part No.	Qty.
5/16–18" Hex Nut	FA68401	100
5/16" USS Flat Washer	FA88446	100
5/16" Alloy Lockwasher	FA529A	250
5/16–18 x 3/4" Capscrew	FA68016	100
5/16–18 x 1" Capscrew	FA68017	50
5/16–18 x 1-1/4" Capscrew	FA68018	50
5/16–18 x 1-1/2" Capscrew	FA68019	50
5/16–18 x 2" Capscrew	FA68021	50



LP797 3/8–16 Grade 8

500 Pieces

NEW!

Description	Part No.	Qty.
3/8–16" Hex Nut	FA68402	100
3/8" USS Flat Washer	FA88447	100
3/8" Alloy Lockwasher	FA530A	100
3/8–16 x 3/4" Capscrew	FA68031	50
3/8–16 x 1" Capscrew	FA68032	50
3/8–16 x 1-1/2" Capscrew	FA68034	50
3/8–16 x 2" Capscrew	FA68036	25
3/8–16 x 2-1/2" Capscrew	FA68038	25

LP798 7/16–14 Grade 8

425 Pieces

NEW!

Description	Part No.	Qty.
7/16–14" Hex Nut	FA68403	50
7/16" USS Flat Washer	FA88448	100
7/16" Alloy Lockwasher	FA531A	100
7/16–14 x 1" Capscrew	FA68046	50
7/16–14 x 1-1/4" Capscrew	FA68047	50
7/16–14 x 1-1/2" Capscrew	FA68048	25
7/16–14 x 2" Capscrew	FA68050	25
7/16–14 x 2-1/2" Capscrew	FA68052	25

LP799 1/2–13 Grade 8

425 Pieces

NEW!

Description	Part No.	Qty.
1/2–13" Hex Nut	FA68404	50
1/2" USS Flat Washer	FA88449	100
1/2" Alloy Lockwasher	FA532A	100
1/2–13 x 1" Capscrew	FA68060	50
1/2–13 x 1-1/2" Capscrew	FA68062	50
1/2–13 x 2" Capscrew	FA68064	25
1/2–13 x 2-1/2" Capscrew	FA68066	25
1/2–13 x 3" Capscrew	FA68068	25

A Quick Tip For You...

Tired of broken studs, wheel bolts, rusted and frozen screws, broken drills, easy-outs and taps?

One low-cost kit provides the right tool for any stud extraction job!

Broken studs and bolts can be quickly and easily removed without the use of easy-outs and taps.

- Works on surface or below-surface breaks
- Specially designed flux protects threads
- Works in any position – horizontal, vertical, overhead



Kit comes in the handy AC1 Welding Rod Drawer

Description	Lawson No.	Pkg. Qty.
Stud Stretcher Equipment Repair Kit	CW3030	1



Wire-Stripping Tool

Easily cuts and strips 20 Ga. to 12 Ga. solid or stranded PVC-insulated wire. Front-loading design allows easy stripping in confined areas. Strips up to 6 conductors of bonded cable simultaneously. Length of stripped section is adjustable, as well as cutter depth, for thick and thin insulation.

Description	Lawson No.	Pkg. Qty.
Wire-Stripping Tool	94280	1



Amber Strobe Light

Commonly used in material handling. Also tested to UL583 Safety Standard; can be used on Type E, ES and EE industrial trucks. 12 to 80V DC, draw 300 – 600 milliamps.

Description	Lawson No.	Pkg. Qty.
Amber Strobe Light	61520	1

Waterproof Wire Connectors

For use in wet or damp outdoor above ground wiring. Use wherever exposure to water is likely, including all outdoor splices lighting pumps and all enclosures, 300vac and 600vac rated and 1000vac for signs and fixtures, for 22 Ga. to 6 Ga. wire combinations

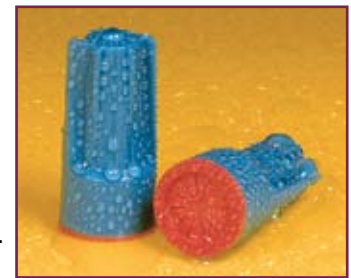

Color	Length (Inches)	O.D. (Inches)	Maximum Voltage	Wire Usage	Lawson No.	Pkg. Qty.
Aqua Blue/Orange	15/16	7/16	300V; 1,000V in Signs & Fixtures	Three 22 Ga. Minimum; Two 14 Ga. Maximum	55367	10
Aqua Blue/Red	1-3/8	5/8	600V; 1,000V in Signs & Fixtures	Three 22 Ga. Minimum; Four 12 Ga.. Maximum	55368	10
Aqua Blue/Dark Blue	1-5/8	13/16	300V; 1,000V in Signs & Fixtures	Four 14 Ga. Minimum; Two 6 and One 12 Ga. Maximum	55369	10

Adhesive Lined 6-to-1 Heat Shrink Tubing

High ratio 6-to-1 Heat Shrink Tubing with a built-in self-sealing adhesive liner provides a watertight seal that's ideal for wet, corrosive and underground applications. Wide application range, five sizes cover 8 Ga. to 2000 MCM cable. Provides strain relief and abrasion resistance. High dielectric strength up to 28,000 volts.



Length (Inches)	I.D. Before Shrinkage (Inches)	I.D. After Shrinkage (Inches)	Wall Thickness Before Shrinkage (Inches)	Maximum Wall Thickness After Shrinkage (Inches)	Lawson No.	Pkg. Qty.
12	0.60	0.150	0.020	0.060	P69220	4
12	1.25	0.220	0.023	0.080	P69256	4
18	2.00	0.375	0.025	0.105	P69225	4
18	3.00	0.750	0.030	0.120	P69215	4
10	4.00	0.900	0.035	0.140	P68806	4



Speed Brake Bleeder Screws

For true one-man brake bleeding capabilities, Speed Brake Bleeder Screws are the solution. It works like this: the one-way check valve in the Speed Brake Bleeder Screw lets air and fluid out when the brake pedal is pumped and closes between pumps, preventing new air from re-entering the system.

SIZE	Lawson No.	Pkg. Qty.
1/4-28 x 1"	64668	4
5/16-24 x 1"	64669	4
3/8-24 x 1.1"	64666	4
7/16-20 x 1.27"	64672	4
M7 x 1.0 x 32mm	64673	4
M8 x 1.25 x 28mm	64670	4
M10 x 1.0 x 33mm	64671	4
M10 x 1.0 x 35mm	64674	4
M10 x 1.50 x 33mm	64667	4

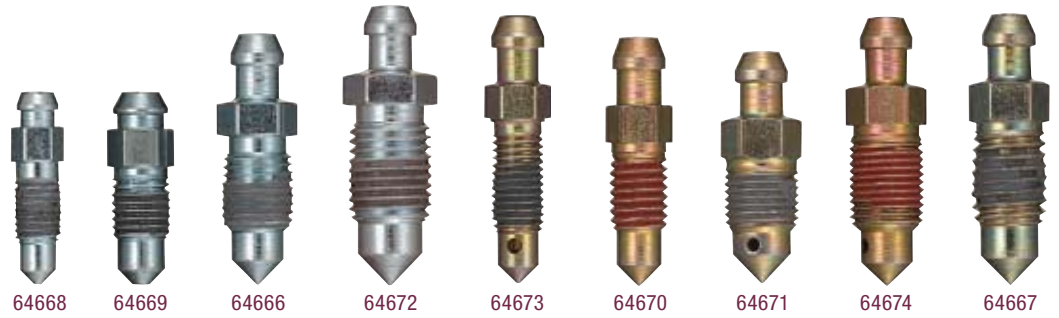

Did You KNOW...

Did you know that AWG (American wire gauge) wire sizes may be determined by measuring the diameter of the conductor wire (the bare wire) with the insulation removed?

American Wire Gauge (AWG)	Diameter in Millimeters	Diameter In Inches
26	0.405	0.016
24	0.511	0.020
22	0.644	0.025
20	0.812	0.032
18	1.024	0.040
16	1.291	0.051
14	1.628	0.064
12	2.053	0.081
8	3.264	0.129
6	4.115	0.162
5	4.621	0.182
4	5.189	0.204
3	5.827	0.229
2	6.544	0.258
1	7.348	0.289
0 (1/0)	8.255	0.325
00 (2/0)	9.271	0.365
000 (3/0)	10.414	0.410
0000 (4/0)	11.684	0.460

For other solutions on how to solve your toughest problems contact your local Lawson agent or 1-866-LAWSON4U.

Experience the **LAWSON DIFFERENCE!**

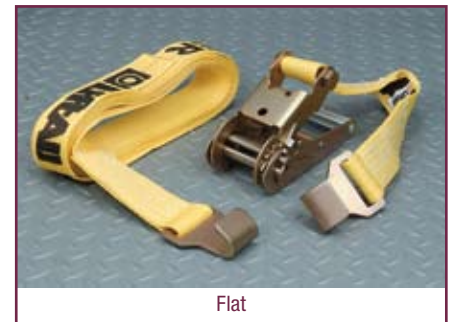

Ratchet-Style Load Huggers

Easy-to-use quick-action ratchet locks loads in place.

Width (Inches)	Length (Ft.)	Buckle Strength (Lbs.)	Hook Type	Lawson No.	Pkg. Qty.
1	10	700	Vinyl S	57561	1
1	15	700	Vinyl S	57562	1
2	15	5,000	Flat	90307	1
2	20	5,000	Flat	90308	1
2	27	5,000	Flat	90309	1

Heavy-Duty Industrial Nylon Two-Ply Flat Eye Slings

Meets OSHA 1910.184 and ANSI B39 specifications.



Width (Inches)	Length (Ft.)	Vertical Hitch Load Capacity (Lbs.)	Basket Hitch Load Capacity (Lbs.)	Choker Hitch Load Capacity (Lbs.)	Lawson No.	Pkg. Qty.
2	3	6,400	12,800	5,000	96322	1
2	6	6,400	12,800	5,000	96323	1
2	8	6,400	12,800	5,000	90301	1
2	10	6,400	12,800	5,000	90302	1

Cronatron™ Welding Systems and Solutions



The Cronatron™ Brand of professional quality welding supplies provide fast and easy solutions for all your welding needs. The Cronatron™ brand is a complete line of welding alloys, hardfacing, brazing alloys, spray powders, metal finishing and safety supplies that are specifically designed to service your systems and procedures. Cronatron™ provides answers to all of your welding needs – now more than ever!



Cronabraz™ 46SP NEW! Silver Bearing Brazing Alloy

This NEW silver-bearing brazing alloy is a lower-cost alternative for copper brazing.

Size (Inches)	Part No.	Pkg. Qty.
1/8 x .050 x 20	CW5763	1
1/16 x .050 x 20	CW5764	1

Cronabraz™ 47SP NEW! Silver Bearing Brazing Alloy

This NEW silver-bearing brazing alloy is ideal for electrical, refrigeration and A/C repairs – provides excellent ductility and superior electric conductivity.

Size (Inches)	Part No.	Pkg. Qty.
1/8 x .050 x 20	CW5765	1
1/16 x .050 x 20	CW5766	1

Wide-Angle, Flip-Up Welding Goggles

Wide-angle viewing with an easy flip-up shade. Comes with a #5 shade and a clear cover plate. Fits the NEW Blue Brazing Lens!

Description	Part No.	Pkg. Qty.
Wide Angle	CW1296	1



Truck Garage Welding Rod Assortment

An assortment of four of our best-selling electrodes for truck maintenance, stored in a handy, wall mount dispenser cabinet. Contains 2 lbs. each of 1/8" Cronacast™ 211 and Cronaweld™ 510, and 3 lbs. each of 1/8" Cronaweld™ 315 and Cronaweld™ 338.

Description	Lawson No.	Pkg. Qty.
Truck Garage Welding Rod Assortment	CW3852	1



Blue Brazing Glasses & Lens

Specifically designed for use during brazing and gas welding. Blue Brazing Glasses and the Blue Brazing Lens provide increased visibility by effectively blocking the yellow/orange glare of the flame.

Description	Part No.	Unit
Blue Brazing Glasses	CW5841	1
Blue Brazing Lens, 2" x 4"	CW5842	1



NEW!



Note how the glare of the flame inhibits the ability to fully see the work area.

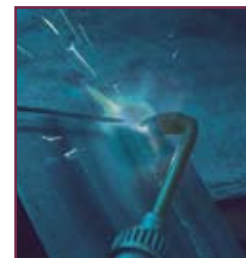

The specially tinted Blue Brazing lens blocks the yellow/orange glare of the flame, increasing visibility!



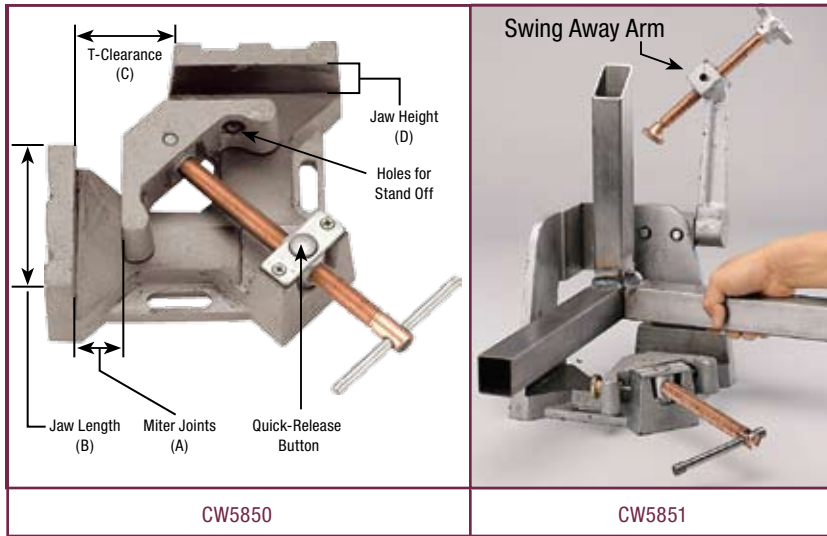

2 Axis Welders Angle Clamp

Rugged cast iron 2-axis clamp easily holds pieces in place for welding.

3 Axis Welders Angle Clamp

Quick-acting swing away 3rd axis arm easily holds upright pieces in place to weld 3-dimensionally.

Description	Miter Joints	Jaw Length B (Inches)	T Clearance C (Inches)	Jaw Height D (Inches)	Weight (Lbs.)	Part No.	Pkg. Qty.
	A (Each Side) (Inches)						
2-Axis Angle Clamp	3.75	4.80	2.45	1.38	11	CW5850	1
3-Axis Angle Clamp	3.75	4.80	2.45	1.38	24.4	CW5851	1



WeldPro 150 Portable Welder/Generator

So lightweight and portable, you can weld almost anywhere!

- Less than 75 pounds
- Reliable Honda engine
- Gas-powered
- Comes with stinger and ground clamp
- For use with electrodes smaller than 5/32"
- DC/CC output of 40A to 150A

Description	Part No.	Pkg. Qty.
WeldPro 150 Welder/Generator w/ Stinger and Ground Clamp	CW5709	1

PURCHASE this.... and RECEIVE this....

BlazeOut Flashback Arrestor Set

Each set includes one fuel and one oxygen flashback arrestor. Meets OSHA, CSA, ISO and ANSI safety guidelines. Protect people and equipment!



Description	CGA Size*	Use With	Part No.	Pkg. Qty.
Regulator Flashback Arrestor Set <i>Set contains a Oxygen Chrome Flashback Arrestor (CW5089), a Fuel Chrome Flashback Arrestor (CW5090) and an 8 oz. bottle of Leak Detection Solution (CW5344).</i>	B	Regulator with Thermal Shutoff, Chrome-Plated	CW5089P	1
Torch Flashback Arrestor Set <i>Set contains a Oxygen Flashback Arrestor (CW5097), a Fuel Flashback Arrestor (CW5098) and an 8 oz. bottle of Leak Detection Solution (CW5344).</i>	B	Torches	CW5097P	1

*B Size – Standard CGA 9/16" UNF Size

Leak Detection Solution

Part No. CW5344



at NO CHARGE!

Offer valid June 1 – 30, 2008. Government entities or public, tax-supported institutions may not be eligible.

FalconGrip Single Drive Socket Sets

FalconGrip Multi-Drive design sockets will work on multiple head styles including 6 and 12 point, SAE and metric.

The 56-piece 1/4" drive socket set is comparable to conventional 71-piece sets. Includes all standard and deep drive sockets ranging from 4mm–5/32" to 14mm, 1/4" drive ratchet, 1/4" x 2" and 1/4" x 6" extensions, 1/4"F x 1/4"F bit adapter and 24-piece insert bit set.

The 67-piece 3/8" drive socket set is comparable to conventional 94-piece sets. Includes standard drive sockets: 6mm, 1/4" and 7mm–9/32"; standard and deep drive sockets ranging from 8mm–5/16" to 24mm - 15/16", 3/8" drive ratchet, 3/8" x 3" and 3/8" x 6" extensions, 3/8"F x 1/4"F bit adapter and 24-piece insert bit set.

The 53-piece 1/2" drive socket set is comparable to conventional 86-piece sets. Includes standard drive sockets: 8mm–5/16", 9mm–11/32", and 10mm–3/8"; deep drive socket: 10mm; standard and deep drive sockets ranging from 3/8" to 32mm–1-1/4", 1/2" drive ratchet, 1/2" x 3" and 1/2" x 5" extensions.

Description	Part No.	Pkg. Qty.
56-pc. 1/4" Drive Socket Set	FA5218	1
67-pc. 3/8" Drive Socket Set	FA5219	1
53-pc. 1/2" Drive Socket Set	FA5220	1

FalconGrip Combination Socket & Wrench Set

One of Lawson's most popular sets. Includes 1/4", 3/8" and 1/2" drive sockets. Comparable to conventional 159-piece sets.

Description	Part No.	Pkg. Qty.
114-pc. 1/4", 3/8" and 1/2" Drive Socket Set and Wrench Set	FA5210	1



Telescoping Magnetic Pick-Up Tool

Features a powerful 5 lb. magnet with shielded sides for targeted pick-ups. Telescopes from 6-1/2" to 33-1/2".

Description	Part No.	Pkg. Qty.
Telescoping Magnetic Pick-Up Tool	FA5175	1



6-in-1 Ratcheting Screwdriver

Includes two reversible bits: #1 Phillips x 3/16" slotted with a 1/4" hex shank; and #2 Phillips x 1/4" slotted with a 5/16" hex shank. Switch allows for forward, reverse, or locked.

Description	Part No.	Pkg. Qty.
6-in-1 Ratcheting Screwdriver	FA5475	1



4-in-1 Multi-Socket

Replace common nutdrivers with one tough tool. Telescoping action provides two socket sizes at each end. Available in fractional (1/4", 3/8", 5/16" and 7/16") and metric (7mm, 8mm, 10mm and 13mm).

Description	Part No.	Pkg. Qty.
SAE 4-in-1 Multi Socket	FA5607	1
Metric 4-in-1 Multi Socket	FA5080	1

